

retigo®

PERFECTION IN COOKING AND MORE...

Blast chiller / freezer **Practic 411, 511**

OPERATING MANUAL



 **READ THIS MANUAL BEFORE USE**

1. INDEX

1. INDEX.....	1
2. ANALYTICAL INDEX.....	2
3. SAFETY.....	3
4. REGULATIONS AND GENERAL INSTRUCTIONS.....	4
4.1. General information.....	4
4.2. Warranty.....	4
4.3. Replacement of Parts.....	4
4.4. Description of the Appliance.....	4
4.5. Features Plate.....	5
4.6. Safety Devices.....	6
5. USE AND FUNCTIONING.....	7
5.1. Description of the Functioning Cycles.....	7
5.2. Description of Controls.....	8
5.3. Functioning.....	9
5.4. Recommendations for Use.....	15
6. CLEANING AND MAINTENANCE.....	16
6.1. Recommendations for Cleaning and Maintenance.....	16
6.2. Routine Maintenance.....	16
6.3. Extraordinary maintenance.....	17
7. TROUBLESHOOTING.....	19
7.1. Faults Display.....	20
8. INSTALLATION.....	20
8.1. Packaging And Unpacking.....	20
8.2. Installation.....	21
8.3. Electric Power Supply Connection.....	22
8.4. Inspection.....	22
8.5. Programming the settings.....	23
9. DISPOSAL OF THE APPLIANCE.....	24
10.REFRIGERANT TECHNICAL CARD.....	24
ATTACHMENTS.....	I

2. ANALYTICAL INDEX**B**

Blast chilling Cycle; 16

C

Cancelling the list of HACCP alarms; 14
 Cleaning the condenser; 17
 Cleaning the evaporator; 17
 Compressor operating hours; 14
 Cooling Cycle; 12

D

Defrosting; 7; 12
 Description of Controls; 8
 Description of the Appliance; 4
 Display of Temperatures; 13
 Disposal of the Appliance; 24

E

Electric Power Supply Connection; 22

F

Faults Display; 20
 Features Plate; 5

G

General information; 4

H

HACCP Alarms; 13
 HACCP alarms display; 13
 Hard Temperature Blast Chilling cycle; 9
 Hard Time Blast Chilling cycle; 10

I

Inspection; 22
 Installation; 21

K

Keyboard lock; 13

P

Packaging; 20
 Preservation; 7
 Programming the settings; 23
 Prolonged Inactivity; 15
 Protective Fuses; 6

R

Recommendations for Cleaning and Maintenance;
 16
 Recommendations for normal use; 15
 Recommendations for Use; 15
 REFRIGERANT TECHNICAL CARD; 24
 Replacement of Parts; 4
 Replacing the fuses; 18
 Routine Maintenance; 16

S

SAFETY; 3
 Safety Devices; 6
 Shock freezing Cycle; 16

T

Temperature Blast chilling; 9
 Temperature Blast Chilling; 7
 Temperature Shock Freezing; 7; 11
 Time and Date SET; 15
 Time Blast Chilling; 7
 Time Blast Chilling cycle; 10
 Time Shock Freezing; 7; 11

U

Unpacking; 20

W

Warranty; 4

3. SAFETY

 **It is recommended to carefully read the instructions and warnings contained in this manual before using the appliance. The information contained in the manual is fundamental for the safety of use and for machine maintenance.**

 Keep this manual carefully so that it can be consulted when necessary.

 The electric plant has been designed in compliance with the IEC EN 60335-2-89 Standard.

 Maintain ventilation openings in the appliance casing or in the built-in structure free from all obstructions.

 Do not use mechanical devices or other means to accelerate the defrosting process, other than those recommended by the manufacturer.

 Do not damage the coolant circuit.

 Do not use electrical appliances inside the appliance compartments for storage of frozen food.

 Do not store explosives, such as pressurised containers with flammable propellant, in this unit.

 Do not place anything on the bottom of the device. Use the appropriate racks to store the product.

 The maximum permissible load for the racks is 45kg evenly distributed.

 if the supply cord is damaged, it must be replaced by the manufacturer, its service agent or similarly qualified persons in order to avoid hazard.

 Specific adhesives highlight the presence of mains voltage in the proximity of areas (however protected) with risks of an electrical nature.

 If a stationary appliance is not fitted with a supply cord and a plug, the means for disconnection must be incorporated in the fixed wiring in accordance with the wiring rules.

In the design and construction phase, the manufacturer has paid particular attention to the aspects that can cause risks to safety and health of persons that interact with the appliance.

Carefully read the instructions stated in the manual and those applied directly to the machine, and particularly respect those regarding safety.

Do not tamper with, evade, eliminate or by-pass the installed safety devices. Failure to comply with this requisite can lead to serious risks for personal health and safety.

It is recommended to simulate some test manoeuvres to identify the controls, in particular those relative to switch-on and switch-off and their main functions.

The appliance is only destined for the use for which it has been designed; any other use must be considered improper.

The manufacturer declines all liability for any damage to objects or injury to persons owing to improper or incorrect use.

 All maintenance interventions that require precise technical skill or particular ability must be performed exclusively by qualified staff.

 When using the appliance, never obstruct the air inlet when the appliance is on, so as not to compromise its performance and safety.



In order to guarantee hygiene and protect the foodstuffs from contamination, the elements that

come into direct or indirect contact with the foodstuffs must be cleaned very well along with the surrounding areas. These operations must only be performed using detergents that can be used with foodstuffs, avoiding inflammable products or those that contain substances that are harmful to personal health.

In the case of prolonged inactivity, as well as disconnecting all the supply lines, it is necessary to accurately clean all internal and external parts of the appliance.

4. REGULATIONS AND GENERAL INSTRUCTIONS

4.1. General information

This manual has been designed by the manufacturer to provide the necessary information to those who are authorised to interact with the appliance.

The persons receiving the information must read it carefully and apply it strictly.

Reading the information contained in this document will allow the user to prevent risks to personal health and safety.

Keep this manual for the entire operating life of the equipment in a place which is well-known and easily accessible, so that it is always available when its consultation becomes necessary.

Particular symbols have been used to highlight some parts of the text that are very important or to indicate some important specifications. Their meanings are given below:



Indicates important information regarding safety. Behave appropriately so as not to risk the health and safety of persons or cause damage.



Indicates particularly important technical information that must not be ignored.

4.2. Warranty

The warranty of the equipment and the components we produce has duration of 2 (two) years from the date of delivery and translates into the supply, free of charge, of parts that we consider to be faulty.

These faults must, however, be independent from incorrect use of the product in compliance with the indications stated in the manual.

Fees deriving from labour, journeys and transport are excluded from the warranty.

The materials replaced under warranty are our property and must therefore be returned under the responsibility and expense of the customer.

4.3. Replacement of Parts



Activate all envisioned safety devices before carrying out any replacement intervention.



In particular, deactivate the electrical power supply using the differential isolating switch. Only use original spare parts to replace worn components.



All responsibility is declined for injury to persons or damage to components deriving from the use of non-original spare parts and interventions which could modify the safety requisites, without authorisation of the manufacturer.

4.4. Description of the Appliance

The Blast chiller-Shock freezer, from now on defined as appliance, has been designed and built to cool and/or freeze foodstuffs in the professional catering ambit.

- 1) **condensation area:** it is positioned in the lower part and is characterised by the presence of the condensing unit.
- 2) **electric area:** it is positioned in the lower part of the appliance and contains the

control and power supply components as well as electric wiring.

- 3) **evaporation area:** it is situated inside the refrigerated compartment in the rear and is characterised by the evaporating unit.
- 4) **storage area:** it is situated inside the refrigerated compartment and is destined for the cooling and/or freezing of foodstuffs.

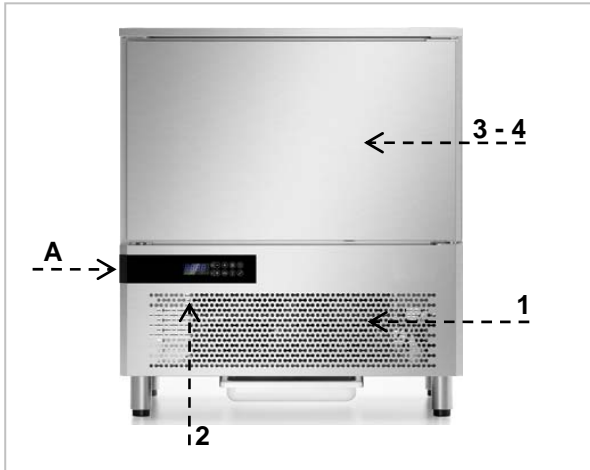

The lower part is also distinguished by a control panel (A) that allows access to the electric parts; there is a vertically-opening door in the front, which closes the refrigerated compartment hermetically.

Depending on requirements, the appliance is produced in several versions.

4 TRAY BLAST CHILLER-SHOCK FREEZER

Model suitable to contain 4 trays with blast chilling capacity of 15 kg and 8 kg in shock freezing.

5 TRAY BLAST CHILLER-SHOCK FREEZER

Model suitable to contain 5 trays with blast chilling capacity of 15 kg and 9 kg in shock freezing.

GB

4.5. Features Plate

The identification plate shown is applied directly onto the appliance. It states the references and all indications indispensable for working in safety.

- 1) Appliance code
- 2) Description of the appliance
- 3) Serial number
- 4) Power supply voltage and frequency
- 5) Rated output
- 6) Defrosting output
- 7) Total light output
- 8) Climatic class
- 9) Type and Amount of refrigerant gas
- 10) WEEE symbol

CODE /KODE CODICE	●	1
MODEL / MODELL MODELLO	●	2
SERIAL No/SERIEN NR. MATRICOLA	●	3
TENSION/SPANNUNG TENSIONE	●	4
INPUT LEISTUNGS-AUFNABME POTENZA	●	5
	●	6
	●	7
CLIMATIC CLASS KLIMAKLASSE CLASSE CLIMATICA	●	8
REFRIGERANT KUEHLMITTEL REFRIGERANTE	●	9
		10

The appliances are equipped with climatic class that indicates the room temperature within which the refrigerator is operating correctly.
The following climatic classes exist:

Climatic Class	Room Temperature °C	Related Humidity %
0	20	50
1	16	80
2	22	65
3	25	60
4	30	55
6	27	70
5	40	40
7	35	75

4.6. Safety Devices

During the running of appliance, some control devices may activate and govern the correct running of the machine. In other cases, they may deactivate parts or the whole machine, to put the appliance in safe conditions. Main controls are described below.

Micro Door



In case the door is opened, the magnetic switch placed on the control board opens and, during blast-chilling or shock-freezing, evaporator fans go off ; if the opening persists for a longer period than the one established on parameter **i2**, it will appear on the display the alarm "**id**" together with a sound signal (until the door is closed).

That condition may also be determined when the door is not perfectly aligned to or near the control board.

Protective Fuses

Some protection fuses in the general power supply line are activated in case of overload.

Condenser Temperature Alarm



In the event of room conditions or functional failures, which cause the condenser to exceed the maximum temperature value established on parameter C6, the alarm "**COH**" will appear on the display, the condenser fan will start.



If the temperature detected by the condenser probe is higher than the in parameter C7 established value, the display will show the alarm "**CSd**"; the running cycle will be stopped. The machine can be run when an acceptable temperature value is reset.

Electrical Power Supply Failure



In the event of a power failure during a working cycle for a period exceeding the value established on parameter A10, once restored the electricity the display will show the alarm "**PF**".

5. USE AND FUNCTIONING

5.1. Description of the Functioning Cycles

The following are brief descriptions and types of operating cycles.

Temperature Blast Chilling



This cycle allows a reduction in temperature in the product core from **+90°C** to **+3°C** as quickly as possible and within a MAX time of **90 minutes**. The cycle ends when the value **+3°C**, read by the needle probe, is reached.

Time Blast Chilling



This cycle allows a reduction in temperature in the product core from **+90°C** to **+3°C** during the set time: we remind you that it is advisable to run some previous testing temperature cycles in order to determine the necessary time for a correct product blast chilling process. Do not forget that acquired times have to be considered valid for exclusive use of the same type of product and in the same quantities per cycle.

Temperature Shock Freezing



This cycle allows a reduction in temperature in the product core from **+90°C** to **-18°C** in the quickest time possible and within a MAX time equal to **270 minutes**. The cycle ends when the value **-18°C**, read by the needle probe, is reached.

Time Shock Freezing



This cycle allows a reduction in temperature in the product core from **+90°C** to **-18°C** during the set time: we remind you that it is advisable to run some previous testing temperature cycles in order to determine the necessary time for a correct product blast chilling process. Do not forget that acquired times have to be considered valid for exclusive use of the same type of product and in the same quantities per cycle.

Preservation

At the end of each cycle as described above, either temperature or time cycle, the preservation cycle will be started automatically, with no time limit. The freezer temperature will refer to last cycle, just concluded:

- **+3°C** for blast chilling
- **-25°C** for shock-freezing

Warning: use of this cycle is recommended only for short periods prior to storage of the product in a storage unit or in case of emergency, so as to avoid such a limited use of a machine with such high potential.



Defrosting

The frost forming on the evaporator following the deposit of humidity from the product can jeopardise the correct functioning of the appliance. A defrosting cycle must be carried out to restore full functionality.

Defrosting is performed by forced ventilation using the evaporator fan. The cycle can be performed with the door open or closed and can also be interrupted at any time.





5.2. Description of Controls



Below a brief description of the functions performed by the control panel buttons.







Blast Chilling Key

Pressing the key with machine still, allows the selection of a temperature blast chilling cycle (+90°C→+3°C). Led  and  are on. A second pressure of the key allows to select a timed blast chilling cycle: led  is off and led  turns on.



Shock Freezing Key

Pressing the key with machine still, allows the selection of a temperature shock freezing cycle (+90°C→-18°C). Led  and  turn on. A second pressure of the key allows to select a timed shock freezing cycle: led  is off and led  turns on.



Time setting Keys

If timed chilling or freezing mode has been selected, these keys make it possible to set the number of minutes the cycle will last. If temperature chilling or freezing mode has been selected, these keys make it possible to set the end chilling or freezing temperature.



Start Key

Once chosen the needed cycle, it can be started by pressing this key, If pressed during functioning, the machine will stop; the previously chosen cycle will persist and can be run immediately.

By pressing this button for at least 5 seconds the machine passes to the stand-by mode. Repeat the procedure to reactivate the board.









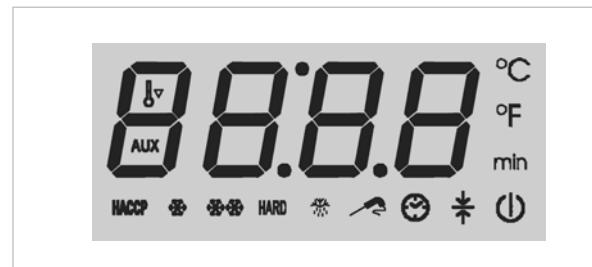



DEFROST Key

When the machine is off a manual defrosting cycle can be started. If the key is pressed again, the defrosting in progress can be stopped.

Display: symbols description







-  blinking: a blast chilling cycle has been selected.
-  on: running blast chilling cycle.
-  blinking: a shock freezing cycle has been selected.
-  On: running shock freezing cycle.
- **HARD** blinking: an intensive blast chilling or shock freezing cycle has been selected.
- **HARD** on: an intensive blast chilling or shock freezing cycle is running.
-  : over cooling function on
-  : preserving cycle on
-  : temperature cycle on
-  : timed cycle on
-  : defrosting cycle on
- **HACCP** : new HACCP alarms stored
-  : stand-by mode



5.3. Functioning

Temperature Blast chilling



Select the blast chilling by pressing  key: led  and  will blink. The display shows the end blast chilling temperature value.

By pressing the  and  keys the temperature value (+3°C) can be changed. Insert the core probe into the product.

Press  key to start. Led  and  will be permanently on.

The test for the proper insertion of the probe will start.

If the test gives a positive result, the blast chilling cycle starts, in case of negative result the machine will run a timed blast chilling (see proper chapter)

During blast chilling the display shows the temperature detected by the core probe. By

pressing the  key, temperature detected by the chamber probe can be visualized.

If the product temperature reaches the established value within the set blast chilling time, the cycle is considered as completed and a preserving cycle is automatically started and an intermittent sound confirm the correct conclusion of the cycle.

In case the product temperature does not reach the on parameter **r5** established value, the cycle

continues: the led  will blink accompanied by an intermittent sound. To stop the alarm press a key.





As soon as product temperature is lower than the established value the blast chilling cycle is considered as completed and a preserving cycle is automatically started.



During preservation the display shows the temperature detected by the chamber probe; LED  is switched on.



Press  to conclude the preservation cycle.

Hard Temperature Blast Chilling cycle



Select blast chilling by pressing  key: LEDs  and  will blink. To select the hard cycle press : LED **HARD** blinks.

The display show the end blast chilling temperature. Using  and  key the end blast chilling temperature (+3°C) can be changed. Insert the core probe into the product. Start the

cycle by pressing the  key. LED , **HARD** and  are permanently on.

The test for the proper insertion of the probe will start.

If the test gives a positive result, the blast chilling cycle starts, in case of negative result the machine will run a timed blast chilling (see proper chapter)

The working set point of the hard phase is established on parameter **r9**. Once the temperature detected by the core probe corresponds to the value established on parameter **r13**, the hard phase is considered as completed.

During blast chilling the display shows the temperature detected by the core probe. By

pressing the  key, temperature detected by the chamber probe can be visualized.

If the product temperature reaches the established value within the established blast chilling time, the cycle is considered as completed and a preserving cycle is automatically started and an intermittent sound confirm the correct conclusion of the cycle.

In case the product temperature does not reach the on parameter **r5** established value, the cycle

continue: the led  will blink accompanied by an intermittent sound. To stop the alarm press a key.

As soon as product temperature is lower than the established value the blast chilling cycle is considered as completed and a preserving cycle is automatically started.

During preservation the display shows the temperature detected by the chamber probe; LED





 is switched on.

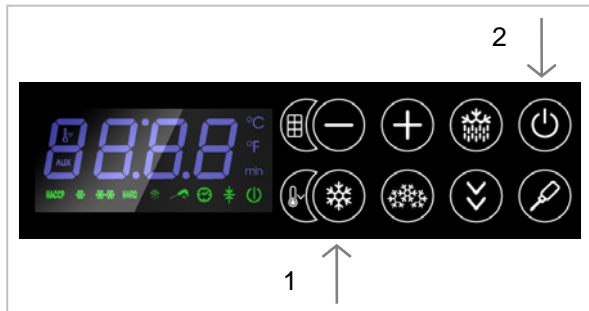

Press  to conclude the preservation cycle.

Time Blast Chilling cycle



Select blast chilling cycle by pressing key

 twice: LED  and  will blink. The display shows the cycle duration. Using  and  keys the blast chilling time can be changed.

Start the cycle by pressing: . LED  and  are permanently on.

At the end of the set time, the blast chilling cycle is concluded and the preserving cycle is automatically started. During preservation the display shows the temperature detected by the



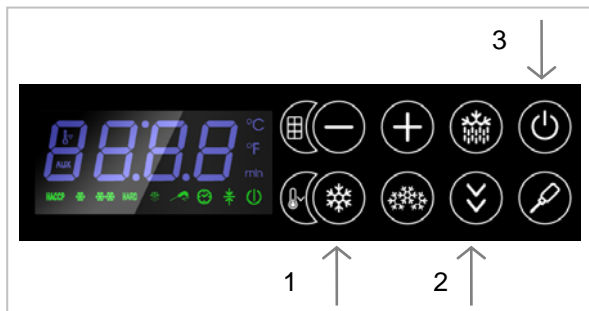

chamber probe, LED  is switched on.

Press  to conclude the preservation cycle.



Hard Time Blast Chilling cycle



Select blast chilling cycle by pressing key

 twice: LED  and  will blink. To select the hard cycle press the  key: LED **HARD** will blink.

Using  and  keys the blast chilling time can be changed.

Start the cycle by pressing: . LED , **HARD** and  are permanently on.

The working set point of the hard phase is established on parameter **r9**. At the end of the on parameter **r14** set time, the hard phase is considered as concluded.





At the end of the set time, the blast chilling cycle is concluded and the preserving cycle is automatically started. During preservation the display shows the temperature detected by the

chamber probe, LED  is switched on.





Press  to conclude the preservation cycle.

Temperature Shock Freezing



Select shock freezing by pressing  key: LED ,  **HARD** and  blink. The display shows the end cycle temperature. Using the and keys the end shock freezing temperature (-18°C) can be changed. Insert the core probe into the product. To select the SOFT cycle press the key.

 LED **HARD** will turn off.

Start the cycle by pressing key . LED ,  and  are permanently on.

The test for the proper insertion of the probe will start.

If the test gives a positive result, the blast chilling cycle starts, in case of negative result the machine will run a timed blast chilling (see proper chapter).

During shock freezing the display shows the temperature detected by the core probe.

By pressing the  key, temperature detected by the chamber probe can be visualized.

If the product temperature reaches the established value within the established time set on parameter **r6**, the cycle is considered as completed: a preserving cycle is automatically started and an intermittent sound confirm the correct conclusion of the cycle.

In case the product temperature does not reach the established value within the maximum time

allowed, the cycle continue: LED  blinks accompanied by an intermittent sound. To stop the alarm press any key.

As soon as product temperature is lower than the established value the shock freezing cycle is considered as completed and a preserving cycle is automatically started.





During preservation the display shows the temperature detected by the chamber probe; LED

 is switched on.

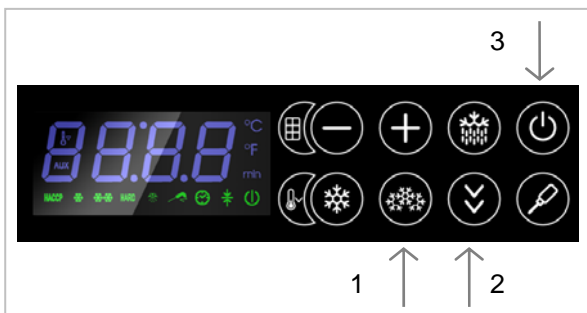
Press  to conclude the preservation cycle.





Time Shock Freezing



Select the freezing process pressing twice the button , the leds ,  **HARD** and  blink. The display shows the time of the cycle.

Using the buttons  and  you can change the time of freezing

To select a soft cycle, press the button : the LED **HARD** will turn off.

To start the cycle, press the button . The leds, ,  and  remain lit steadily.

At the end of the setted time, the freezing cycle is completed and automatically starts a cycle of conservation.

During the storage phase the display shows the temperature measured by the room probe, the



LED  is turned on.

Press the button  to end the cycle of conservation.

GB

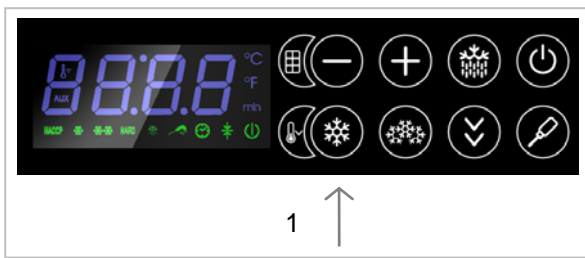

Cooling Cycle



Select the cooling cycle by pressing for two seconds  key: LED  blinks: a cooling cycle will be started. The working set point is established on parameter **r12**. When the chamber temperature reaches the set value, the cycle

continue, LED  is permanently on accompanied by a one second sound signal.



Defrosting



First make sure there is no preservation cycle running. Press for at least four seconds key : LED  will be switched on.

Defrosting is performed by forced ventilation using the evaporator fan. The cycle can be performed

with the door open or closed and can also be interrupted at any time using  key.







Keyboard lock





It is possible to lock the keyboard. By pressing the keys  and  for a second: the display will show "Loc" for one second.

To unlock the keyboard, press the keys  and  for a second: the display will show "Unl" for one second.

Display of Temperatures



Make sure the keyboard is not blocked and that there is no cycle running.

- Press  key for a second: the display shows the first available message.
- By using keys  and  select the "Pb1" message (chamber probe).
- Press  to visualize the value detected by the chamber probe.
- Pressing  the display will again show "Pb1".
- Press  key: the display will show the message "Pb2" (core probe).

- Press  to visualize the value detected by the core probe.
- Pressing  the display will again show "Pb2".
- Press  key: the display will show the message "Pb4" (condenser probe).
- Press  to visualize the value detected by the condenser probe.

Core Probe Heating

Make sure the keyboard is not blocked and there is no cycle running.

Press  key for a second: LED  blinks and LED  turns on.

When the temperature detected by the core probe reaches the value established on parameter u7,

the cycle is concluded, a sound signal is activated for one second.

HACCP Alarms

The device can store up to 9 different HACCP alarms, thereafter a new one will overwrite the oldest one. The device gives following information:

- Alarm code
- critical value
- date and time when die alarm occurred
- Alarm duration (from 1 min to 99h and 59 min, partial if the alarm is still active).

Below a list of existing codes:

- **time:** temperature blast chilling/shock freezing alarm, the cycle exceeded the time limit. the alarm stores the temperature detected by the core probe at the end of the established time.
- **AH:** maximum temperature alarm during preservation. The alarm stores the

maximum temperature of the chamber probe.



- **PF** power supply failure during preservation. The alarm stores the room temperature when restoring electricity.

 To avoid having to memorize power failure alarms repeatedly, disconnect the power supply when the tool is in stand-by mode.



 If the duration of the power failure alarm is such that it causes a clock error (code "rtc"), the device will not provide any information regarding the duration of the alarm



HACCP alarms display

Make sure the keyboard is not locked.

Keep the  key pressed for 1 second: the screen will display the letters "rtc". Press the  key repeatedly until the letters "LS" appear. Press

the  key: the screen will display the code for the most recent alarm (in other words one of the codes listed above followed by number "1"; the greater the number that follows the code for the

alarm, the older it is). With the  and  keys it is possible to scan the various memorised alarms.

To select an alarm press the  key: the  led will stop flashing and stay on steadily, the screen will display the following information in sequence :

8.0	the critical value is 8.0 °C/8 °F
StA	the screen is about to display the date and time when the alarm was set off
y09	the alarm was set off in 2009 (continue ...)
n03	the alarm was set off in the month of

	March (continue ...)
d26	the alarm was set off on March 26, 2009
h16	the alarm was set off at 16:00 (continue ...)
n30	the alarm was set off at 16:30 (continue ...)
dur	the screen will display the duration of the alarm
h01	the alarm lasted for 1 h (continue ...)
n15	the alarm lasted for 1 h and 15 min
AH3	the selected alarm

The screen displays every piece of information for 1 second.

To exit the sequence of information: press and release the  key, the screen displays the selected alarm ("AH3" in the example).

To exit the procedure press the  key: the screen will display the temperature read by the cold room probe again.

 If the tool does not have any alarms in its memory, the "LS" label will not be displayed.

Cancelling the list of HACCP alarms

Make sure the keyboard is not locked.

Keep the  key pressed for 1 second: the screen will display the letters "rtc".

Press the  key repeatedly until the letters "rLS" appear.

Press the  key: the password will be requested in order to cancel the alarms from the memory.

With the  and  keys enter the password

149: press the  key to confirm the deletion of the alarms.

 If the tool does not have any alarms in its memory, the "rLS" label will not be displayed.

Compressor operating hours

The tool is capable of memorising up to 9,999 hours of compressor operation, after which the number "9999" will flash.

To view the hours of compressor operation follow the instructions below.

Make sure the keyboard is not locked.

Keep the  key pressed for 1 second: the screen will display the letters "rtc".

Press the  key repeatedly until the letters "CH" appear.

Press the  key to view the data. To reset the counter to zero follow the instructions below.

Make sure the keyboard is not locked.

Keep the  key pressed for 1 second: the screen will display the letters "rtc".

Press the  key repeatedly until the letters "rCH" appear.

Press the  key: the password is required in order to reset the counter to zero.



With the  and  keys enter the password





149: press the  key to confirm.



Time and Date SET

Make sure the keyboard is not locked.



Press the button  for one second, the display will show the first label available



Press the button  or  until the display shows "rtc".



Press and release the button  : the display will show "yy" followed by the last two numbers of the year and the LED  will flash. Using the button  or  you can set the current year.



Press the button  to save the data and move to the modification of the month : the display will show "nn" followed by the two numbers of the month. Using the button  or  you can set the current month.

Press the button  to save the data and move to the modification of the day : the display will show "dd" followed by the numbers of the day.

Using the button  or  you can set the current day.

Press the button  to save the data and move to the modification of the hour : the display will show "hh" followed by the two numbers of the hour. Using the button  or  you can set the current hour.

Press the button  to save the data and move to the modification of the minutes : the display will show "nn" followed by the two numbers of the minutes. The time is shown in 24 hour format. With the button  or  you can set the correct value.

Press and release the button  or do not operate for 15 seconds, the LED  will turn off.

GB

5.4. Recommendations for Use

Prolonged Inactivity

If the appliance remains inactive for a long period, proceed as follows:

1. Use the automatic isolating switch to deactivate connection to the main electrical line.
2. Clean the appliance and surrounding areas thoroughly;
3. Spread a thin layer of cooking oil onto the stainless steel surfaces;
4. Carry out all maintenance operations;
5. Leave the doors ajar to prevent the formation of mould and/or unpleasant odours.

Recommendations for normal use

In order to ensure correct use of the appliance, it is good practice to apply the following recommendations:



Do not obstruct the zone in front of the condensing unit in order to favour heat disposal from the condenser to a maximum. Always keep the front of the condenser clean.



Do not insert foodstuffs that are well above the temperature of 90°C. As well as initially overloading the machine it can make protections intervene that prolong temperature descent times.

If possible, a brief external period is useful to lower the temperature to acceptable values. Check the planarity of the appliance rest surface.



Do not stack the materials to be preserved in contact with the internal walls, so blocking the circulation of air, which guarantees uniformity of the internal temperature of the refrigerated compartment.



There must be a sufficient space between the basins and trays used in order to guarantee a sufficient flow of cold air on the entire product. Therefore avoid the following positions of trays and/or basins stated below.



Never obstruct the inlet of the evaporator fans.



Products that are more difficult to chill because of their composition and size should be placed in the centre.

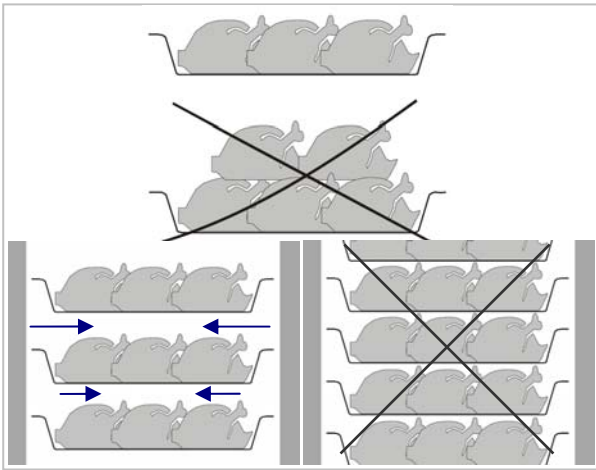

Limit the number of times and the duration of time the doors are opened.

⚠ Blast chilling data refer to standard products (low fat content) with a thickness below 50 mm; therefore avoid overlaying products or the insertion of pieces with a much higher thickness. This would, in fact, lead to an extension of blast chilling times. Always distribute the product well on the trays or basins or in the case of thick pieces decrease the amount to blast chill.

i After blast chilling/shock freezing the product, it can be stored in a preservation cabinet after having been duly protected. A tag should be applied describing the contents of the product, blast chilling/shock freezing date and expiry date. *When the product has been blast chilled it must be preserved at a constant temperature of +2°C, while if it has been shock frozen it must be preserved at a constant temperature of -20°C.*

i The chiller should be used for storage for short periods only.

⚠ To prevent bacterial contamination or contamination of any other biological nature, the needle probe must be disinfected after use.

⚠ To extract the product that has undergone blast chilling or shock freezing, always wear gloves to protect the hands, as "burns" may occur from the cold.

i Blast chilling Cycle

With this operating modality the chiller keeps the temperature of the refrigerating compartment close to zero during the entire chilling process in order to ensure a gradual drop in the temperature of the product to +3°C. In this way, ice crystals do not form on the surface of the product. This blast chilling method should be used preferably for products that are not packed and whose physical/organoleptic characteristics could be damaged by the formation of superficial ice (e.g. fish).

i Shock freezing Cycle

With this blast chilling modality the blast chiller maintains the temperature at a negative value below -18°C which is the end temperature of shock freezing. For shock freezing to be successful and fast, food should be in small pieces, especially if it has a high fat content. The largest pieces should be placed in central trays. If it takes longer than standard time to shock freeze and the sizes cannot be reduced, decrease the quantity and precool the chiller compartment by starting an empty shock freezing cycle before shock freezing the product.

6. CLEANING AND MAINTENANCE

6.1. Recommendations for Cleaning and Maintenance

⚠ Activate all envisioned safety devices before carrying out any maintenance interventions. In

particular, deactivate the electrical power supply using the automatic isolating switch.

6.2. Routine Maintenance

Routine maintenance consists of daily cleaning of all the parts which can come into contact with foodstuffs and the periodic maintenance of the burners, nozzles and draining pipes.

Correct maintenance allows the user to maximise performance levels and operating life and constantly maintain safety requirements.

Do not spray the appliance with direct jets of water or using high pressure appliances.

Do not use iron wool, brushes or scrapers to clean the stainless steel as ferrous particles could be deposited which, on oxidising, could lead to rust.

To remove hardened residues, use wooden or plastic spatulas or abrasive rubber pads.

During long periods of inactivity, spread a protective layer on all stainless steel surfaces by

wiping them with a cloth soaked in Vaseline oil and airing the rooms periodically.



Do not use products which contain substances which are harmful and dangerous for personal health (solvents, petrol etc.).

At the end of the day it is advisable to clean:

- the cooling compartment
- the appliance.

6.3. Extraordinary maintenance

Have the following operations carried out **periodically** by specialised staff:

- Check the perfect sealing of the door gaskets and replace them if necessary.
- Check that the electric connections have not loosened.
- Check the efficiency of the heating element resistance
- Check functioning of the board and probes.
- Check the efficiency of the electrical system.
- Clean the evaporator.
- Clean the condenser.

Cleaning the evaporator

Clean the evaporator **periodically**.

 As the fins of the evaporator are very sharp, always wear protective gloves for the next phases. Only a brush must be used for cleaning: do not use jets of liquid or sharp instruments. To access the evaporator proceed as follows:

1. Open the door (A) of the appliance.
2. Loosen the two screws (B) on the right of the deflector.
3. Remove the runners (C):
4. Turn the deflector (D) to the left

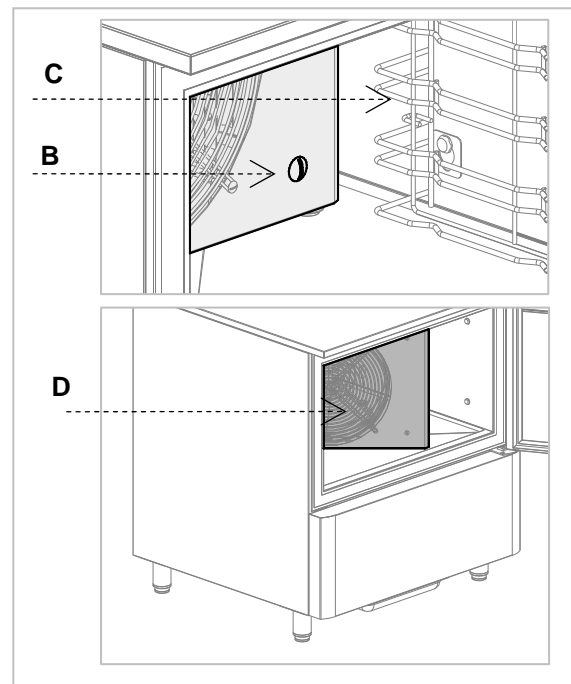
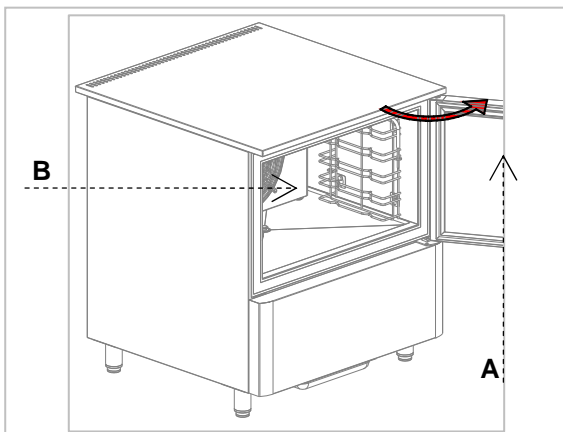

Cleaning the condenser

Clean the condenser **periodically**.



As the fins of the condenser are very sharp, always wear protective gloves for the next

phases. Use protective masks and glasses in the presence of dust.

i Whenever the condenser has a deposit of dust in correspondence with the fins, this can be removed using a suction device or with a brush applied, using a vertical movement along the direction of the fins.

! No other instruments must be used, which may deform the fins and therefore the efficiency of the appliance.

To clean, proceed as follows:

1. Open the door (A) of the appliance.
2. Remove the lower panel (B) from the technical compartment: to do this, remove the screw fasteners (C).
3. It is now possible to clean the finned part of the condenser (D) using suitable tools and protection devices.
4. After cleaning, close the control panel and fix it with the screws removed beforehand.

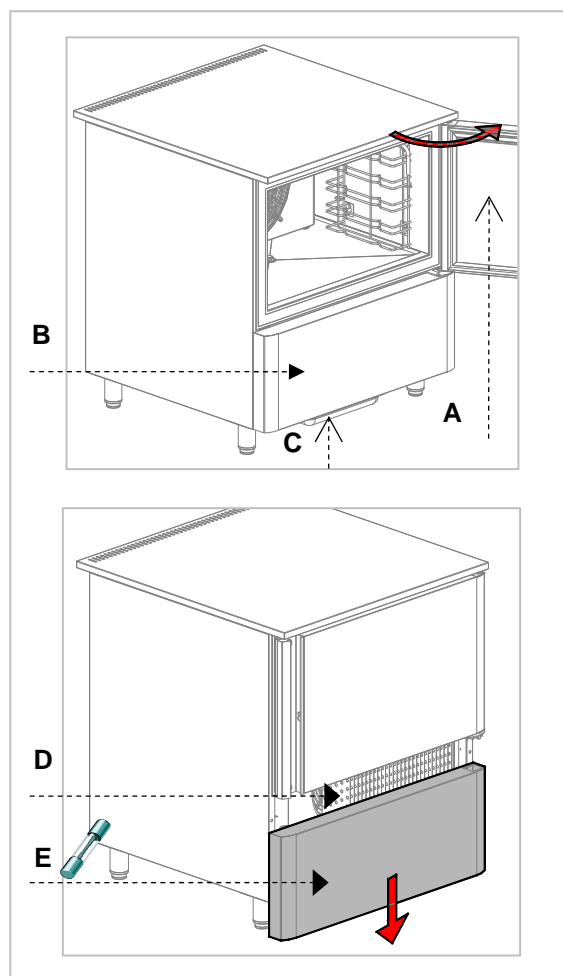







Replacing the fuses

i The fuses are in the lower part of the technical compartment (E). To access these, open the control panel using the same method listed for the access and cleaning of the condenser.



7. TROUBLESHOOTING

The information shown below aims to help with the identification and correction of any anomalies and malfunctions which could occur during use. Some of these problems can be resolved by the

user. For the others, precise skill is required and they must therefore only be carried out by qualified staff.

Problem	Causes	Solutions
The refrigerator unit does not start	No voltage	Check the power supply cable.
		Check fuses.
	Other causes	 If the problem persists, contact the after-sales centre.
The refrigerator unit functions continuously, cooling insufficiently	Room too hot	Air the environment
	Dirty condenser	clean the condenser
	Insufficient door sealing	check the gaskets
	Insufficient quantity of refrigerant gas	 Contact the after-sales centre.
	Condenser fan at a standstill	 Contact the after-sales centre.
	Evaporator fan standstill	 Contact the after-sales centre.
The refrigerator unit does not stop	Probe faulty	 Contact the after-sales centre.
	Circuit board fault	 Contact the after-sales centre.
Presence of ice inside the evaporator		Carry out a defrosting cycle possibly with the door open.
		 If the problem persists, contact the after-sales centre.
Appliance noise	Persistent vibrations	check there is no contact between the appliance and other objects inside or outside

7.1. Faults Display

Problem		Causes	Solutions
Pr1	"Pr1" flashes on the display and the buzzer emits an intermittent noise (compartment probe error)	<ul style="list-style-type: none"> ➤ The type of probe is incorrect. ➤ The probe is faulty. ➤ The probe – circuit board connection is incorrect. ➤ The temperature detected by the probe is out of the limits accepted by the compartment probe in use 	 Contact the after-sales centre. <ul style="list-style-type: none"> ➤ Check that the compartment probe is the PTC type. ➤ Check the integrity of the compartment probe. ➤ Check correctness of the instrument - probe connection. ➤ Check that the temperature in proximity of the compartment probe is not out of the accepted limits
Pr4	"Pr4" flashes on the display and the buzzer emits an intermittent noise (condenser probe error)		
Pr2	"Pr2" flashes on the display and the buzzer emits an intermittent noise (needle probe error)		
rtc	"rtc" flashes on the display	Clock error	Set date and correct time again.
Pf	"Pf" flashes on the display and the buzzer emits an intermittent noise (electrical power supply failure alarm)	There has been a power failure.	<ul style="list-style-type: none"> ➤ Check the electrical system.  Contact the after-sales service if the problem persists.
COH	"COH" flashes on the display and the buzzer emits an intermittent noise (condenser temperature alarm)	The temperature detected by the condenser probe is higher than the established value (parameter C6).	<ul style="list-style-type: none"> ➤ Air the environment ➤ Clean the condenser. ➤ Check fans are working properly. Contact the after-sales service if the problem persists.
CSd	"CSd" flashes on the display and the buzzer emits an intermittent noise (condenser fan blocked alarm)	The temperature detected by the condenser probe is higher than the established value (parameter C7).	<ul style="list-style-type: none"> ➤ Check fans are working properly.  Contact the after-sales service

8. INSTALLATION

8.1. Packaging And Unpacking

Handle and install the appliance respecting the information provided by the manufacturer, shown directly on the packaging, on the appliance and in this manual.

truck or a pallet stacker. When using these, particular attention must be paid to balancing the weight in order to prevent the risk of overturning (avoid excessive tilting!).

The lifting and transportation system of the packaged product envisions the use of a fork-lift

 **ATTENTION:** When inserting the lifting device, pay attention to the power supply cable and the position of the feet.

The packaging is made of cardboard and the pallet of wood. A series of symbols is printed on the cardboard packaging which highlights, in accordance with international standards, the provisions to which the appliances are subjected during loading, unloading, transport and storage.



On delivery, check that the packaging is intact and has not undergone any damage during transportation.

The transportation company must be notified of any damage immediately.

The appliance must be unpacked as soon as possible to check that it is intact and undamaged.

Do not cut the cardboard with sharp tools so as not to damage to the steel panels underneath.

Pull the cardboard packaging upwards.

After having unpacked the appliance, check that the features correspond to those requested in the order;

Contact the dealer immediately if there are any anomalies.

 Packaging elements (nylon bags, polystyrene foam, staples ...) must not be left within reach of children.

Remove the protective PVC film from the internal and external walls, avoiding the use of metal tools.

8.2. Installation

 Commissioning and installation procedures are to be performed by qualified personnel.

All the installation phases must be considered, from the moment of creation of the general plan.

The installation area must be equipped with all power supply and production residue drainage connections and must be suitably lit and respect current laws regarding hygiene and sanitary requirements.

 The performance of the appliance is guaranteed with a room temperature of 32°C. A higher temperature can compromise its performance and, in more serious cases, cause the appliance's protections to start up. Therefore, consider the most critical room conditions that can be reached in that position before making a choice.

Level the appliance by acting on the individual feet.

 Do not push or drag the device during installation to avoid tipping or damages to parts of it.

 This appliance can only be installed and operate in rooms which are permanently ventilated, in order to guarantee correct operation.

 Connect and leave for a certain period of time (at least 2 hours) before checking functioning. During transport it is probable that the compressor lubricant oil has entered the refrigerant circuit blocking the capillary: as a consequence the appliance will function for a certain period of time without producing cold until the oil has returned to the compressor.

 **ATTENTION:** the appliance requires the minimum functioning spaces, as shown in the attachments.

The defrosting water and the water that forms at the bottom of the refrigerating compartment during operation or during periodical internal cleaning must be drained through a prearranged hose with a minimum diameter 3/4" connected to the hose at the bottom of the chiller.

A drain trap should also be guaranteed. The drain must be in compliance with Standards in force.

8.3. Electric Power Supply Connection

Connection must be carried out by authorised and qualified staff, respecting the current laws regarding the subject and using appropriate prescribed material.



Before connecting the appliance to the electric mains, check that the voltage and the frequency correspond to the data stated on the registration plate applied on the rear of the appliance.



The equipment is supplied with one of the following operating voltages:

- 230V 1~ 50Hz
- 220V1~ 60Hz.



Before connection, ensure the presence of a relevant differential switch with adequate power in the mains power supply, upstream from the appliance, in order to protect the appliance from overloads or short circuits

8.4. Inspection

The appliance is delivered in conditions such that it can be started-up by the user.

This functionality is guaranteed by passing the tests (electric inspection - functional inspection, appearance inspection) and relative certification through the specific attachments.

At least the following should be checked after installation:

- Check the electric connections.

- Check the functionality and efficiency of drains.
- Check that there are no tools or materials left in the appliance that could jeopardise its functionality or even damage the machine.
- Have the appliance perform at least one complete chill blasting/shock freezing cycle

8.5. Programming the settings

It is only possible to program the configuration settings in **STANDBY** mode.



Make sure the keyboard is not locked.

Hold the  and  keys down for 4 seconds: the screen will display the letters "PA".





Press the  key: the password will be required to access the parameters.



With the  and  keys enter the password

19 : press the  key to confirm.

Hold the  and  keys down for 4 seconds: the screen will display the letters "SP" (first available parameter).

With the  and  keys it is possible to scan the list of parameters

Press the  key to change the parameter using the  and  keys: press the  key to confirm the change.

To exit the procedure hold the  and  keys down for 4 seconds.

 To make some of the parameters operational it is necessary to turn the appliance off and on again.

9. DISPOSAL OF THE APPLIANCE

 This appliance is marked in compliance with the 2002/96/EC European Directive, WASTE ELECTRICAL AND ELECTRONIC EQUIPMENT (WEEE).

 By assuring that this product is disposed of correctly, the user contributes to preventing the potential negative consequences on the environment and health.



The symbol found on the product or on the accompanying documentation indicates

that this product must not be treated as domestic waste but must be taken to suitable collection points for the recycling of electric and electronic appliances.

Dispose of it following local regulations regarding waste disposal.

For further information regarding the treatment, recovery and recycling of this product, contact the relevant local office, the domestic waste collection service or the shop where the product was purchased.

GB

10. REFRIGERANT TECHNICAL CARD

The refrigerant used in the machine is R404a fluid. Below find the components of the fluid:

PENTAFLUOROETHANE (HFC R125)
44%

ETHANE 1,1,1 – TRIFLUORO (HFC R143A)
52%

ETHANE 1,1,1,2 TETRAFLUORO (HFC R134A) 4%

IDENTIFICATION OF DANGERS

The rapid evaporation of the liquid can cause freezing. The inhalation of high concentrations of vapour can cause irregular heartbeat, short term narcotic effects (including vertigo, headache and mental confusion), fainting and death.

- Effects to the eyes: Freezing or cold burns caused by contact with the liquid.
- Effects on the skin: Freezing or cold burns caused by contact with the liquid.

- Effects of ingestion. Ingestion is not considered a means of exposure

FIRST AID

Eyes: In the case of contact, wash the eye well using a large amount of water for at least 15 minutes. Consult a doctor.

Effects on the skin: Wash with water for at least 15 minutes after excessive contact. If necessary, cure freezing by gently warming the area in question. Consult a doctor in the case of irritation.

Ingestion: Ingestion is not considered a means of exposure.

Inhalation: If large concentrations are inhaled, go into the open air. Keep the person calm. If the person cannot breathe, perform artificial respiration. If respiration is difficult, apply oxygen. Consult a doctor.

retigo[®]

PERFECTION IN COOKING AND MORE...

RETIGO s.r.o.

Láň 2310

756 61 Rožnov pod Radhoštěm

Email: info@retigo.cz

Tel.: +420 571 665 511

www.retigo.com